



认证号: E133481



认证号: 40048406



认证号: CQC17002183722



### 特性

- 多种类型继电器, 包括内置发光二极管
- 具有二、四组转换触点形式
- 防尘罩型封装形式
- 线圈触点间耐压2000V
- 高电寿命
- 高机械寿命
- 带测试按钮规格
- 自动化生产

### 触点参数

触点形式	2Z	4Z
接触电阻 <sup>(1)</sup>	≤100mΩ (1A 6VDC)	
触点材料	详见订货标记	
触点负载(阻性)	7A 220VAC/24VDC	5A 220VAC/24VDC
	5A 220VAC/24VDC	3A 220VAC/24VDC
最大切换电压	277VAC / 30VDC	
最大切换电流	7A	5A
最大切换功率	1939VA / 210W	1385VA / 150W
机械耐久性	5 × 10 <sup>7</sup> 次(直流型)	
	2 × 10 <sup>7</sup> 次(交流型)	
电耐久性 <sup>(2)</sup>	2Z:室温下, 阻性负载7A 277VAC或7A 30VDC, 1s通9s断, 1x10 <sup>5</sup> 次	
	4Z:室温下, 阻性负载5A 277VAC或5A 30VDC, 1s通9s断, 1x10 <sup>5</sup> 次	

备注: (1) 上述值均为初始值。

(2) 详细电耐久性信息情况请见性能曲线图, 如有其它条件需求, 可与我司联系。

### 线圈参数

额定线圈功率	直流型: 约(0.8 ~ 1.1)W; 交流型: 约(0.9 ~ 1.5)VA
--------	--

### 线圈规格表

23°C

额定电压 VDC	动作电压 VDC <sup>(1)</sup>	释放电压 VDC	最大电压 VDC <sup>(2)</sup>	线圈电阻 Ω
6	≤4.8	≥0.60	6.6	41 x (1±15%)
12	≤9.6	≥1.20	13.2	165 x (1±15%)
24	≤19.2	≥2.40	26.4	662 x (1±15%)
48	≤38.4	≥4.80	52.8	2725 x (1±15%)
100/110	≤80.0	≥11.0	110/121	11440 x (1±15%)
220	≤170.0	≥22.0	242	53780 x (1±15%)

### 性能参数

绝缘电阻	1000MΩ (500VDC)	
介质耐压	线圈与触点间	2000VAC 1min
	断开的触点间	1000VAC 1min
	触点组之间	2000VAC 1min(2Z) 1500VAC 1min(4Z)
动作时间(额定电压下)	≤20ms	
释放时间(额定电压下)	≤15ms(直流型)、≤25ms(交流型)	
线圈温升	≤85K	
冲击	稳定性	200m/s <sup>2</sup> (NO)、100m/s <sup>2</sup> (NC)
	强度	1000m/s <sup>2</sup>
振动	10Hz ~ 55Hz 1mm 双振幅	
湿度	5% ~ 85% RH	
温度范围	-40°C ~ 70°C	
引出端形式	插入式	
重量	约40g	
封装方式	防尘罩型	

备注: (1) 上述值均为初始值。

额定电压 VAC	动作电压 VAC <sup>(1)</sup>	释放电压 VAC	最大电压 VAC <sup>(2)</sup>	线圈电阻 Ω
12	≤9.60	≥3.60	13.2	46 x (1±15%)
24	≤19.2	≥7.20	26.4	180 x (1±15%)
48	≤38.4	≥14.4	52.8	788 x (1±15%)
100/110	≤80.0	≥33.0	110/121	3750 x (1±15%)
110/120	≤88.0	≥36.0	121/132	4430 x (1±15%)
200/220	≤160.0	≥66.0	220/242	12950 x (1±15%)
220/240	≤176.0	≥72.0	242/264	15920 x (1±15%)

备注: (1) 常温下, 让继电器正常动作时, 需要在继电器的线圈脚施加电压的最小值不得低于额定电压值的80%, 但为了达到规定的产品性能, 使用时请对线圈施加额定电压;

(2) 最大电压是指继电器线圈在短时间能够承受的最大电压值。



宏发继电器

ISO9001、ISO/TS16949、ISO14001、OHSAS18001、IECQ QC080000 认证企业

2019 Rev. 1.05

## 安全认证

UL/CUL	2Z	7A 277VAC或7A 30VDC, 阻性, 70°C
	4Z	5A 277VAC或5A 30VDC, 阻性, 70°C
CQC	2Z	7A 277VAC或7A 30VDC, 阻性, 70°C
	4Z	5A 277VAC或5A 30VDC, 阻性, 70°C
VDE	2Z	7A 277VAC或7A 30VDC, 阻性, 70°C
	4Z	5A 277VAC或5A 30VDC, 阻性, 70°C

备注:(1) 以上仅列出该产品认证的部分典型负载, 每个负载的详细测试条件不同, 因此电耐久性次数不一样, 如需了解详细情况, 请与我司联系。

## 订货标记示例

继电器型号		HF18FZ/ A 12 -2Z 2 3 J 1 G (XXX)	
线圈电源	A: 交流(50Hz或60Hz) 无: 直流		
线圈电压	直流: (6 ~ 220)VDC 交流: (12~ 240)VAC		
触点形式	2Z: 两组转换    4Z: 四组转换		
引出端形式	2: QC引出端		
触点材料	3: AgNi		
组合元件代号	无: 不带组合元件    J: 带续流二极管		
交互界面功能代号	1: 无LED无按钮型    2: 带LED无按钮型    3: 带LED带按钮型		
镀层代号	G: 镀金    无: 不镀金		
特性号 <sup>(1)</sup>	XXX: 客户特殊要求    无: 标准型		

备注: (1) 客户特殊要求由我司评审后, 按特性号的形式标识;

(2) 对于额定电压<110VDC的产品具备带续流二极管型产品。

外形图

HF18FZ/□□□□-2Z2□□□1□  
 HF18FZ/□□□□-2Z2□□□2□

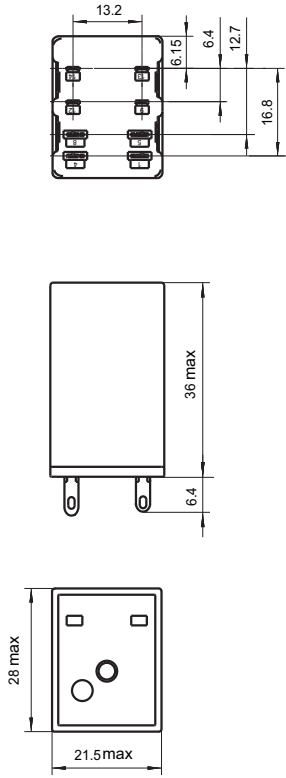

HF18FZ/□□□□-2Z2□□□3□

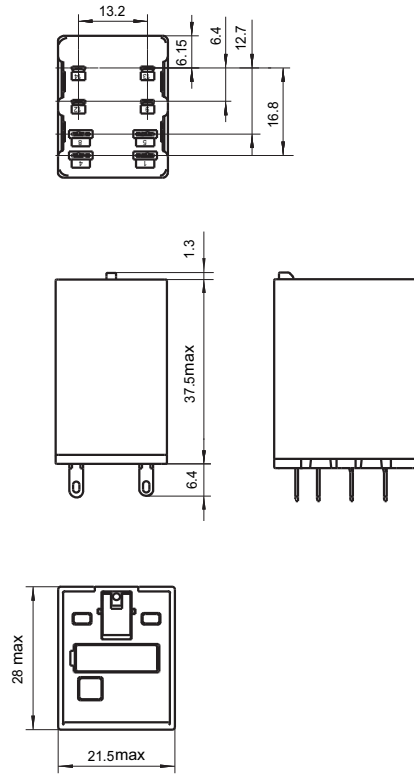

HF18FZ/□□□□-4Z2□□□1□  
 HF18FZ/□□□□-4Z2□□□2□

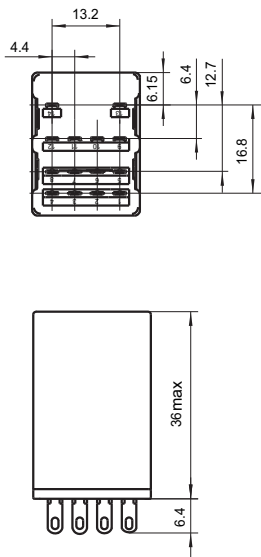

HF18FZ/□□□□-4Z2□□□3□

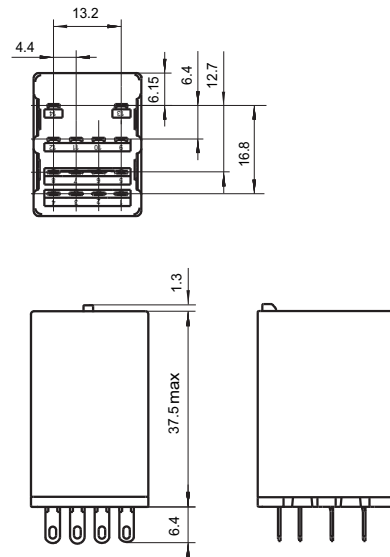

HF18FZ/□□□□-4Z2□□□1□  
HF18FZ/□□□□-4Z2□□□2□

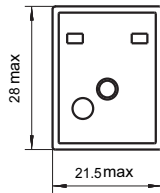

HF18FZ/□□□□-4Z2□□□3□

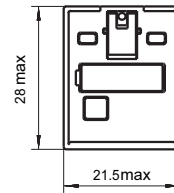

备注: 产品部分外形尺寸未注尺寸公差, 当外形尺寸 $\leq 1\text{mm}$ , 公差为 $\pm 0.2\text{mm}$ ; 当外形尺寸在 $(1 \sim 5)\text{mm}$ 之间时, 公差为 $\pm 0.3\text{mm}$ ; 当外形尺寸 $> 5\text{mm}$ , 公差为 $\pm 0.4\text{mm}$ 。

接线图(底视图)

HF18FZ/□□□□-2Z232  
HF18FZ/□□□□-2Z233

2Z直流带发光二极管  
(不包括220VDC)

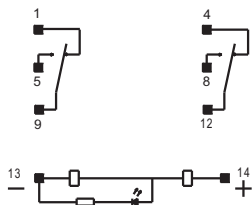

HF18FZ/□□□□-2Z23J2  
HF18FZ/□□□□-2Z23J3

2Z直流带发光二极管和续流二极管  
(不包括220VDC)

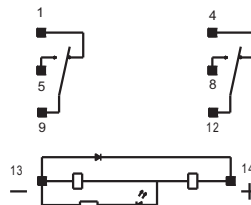

HF18FZ/A□□□□-2Z232  
HF18FZ/A□□□□-2Z233

2Z交流带发光二极管

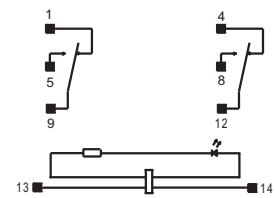

HF18FZ/220-2Z232  
HF18FZ/220-2Z233

2Z直流带发光二极管  
(220VDC)

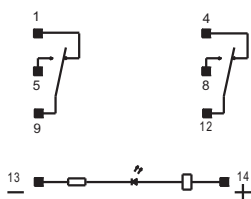

HF18FZ/220-2Z23J2  
HF18FZ/220-2Z23J3

2Z直流带发光二极管和续流二极管  
(220VDC)

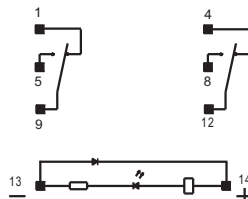

## 接线图(底视图)

HF18FZ/□□□-4Z232  
HF18FZ/□□□-4Z233

4Z直流带发光二极管  
(不包括220VDC)

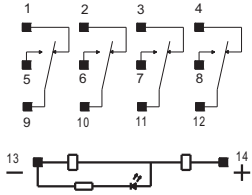

HF18FZ/□□□-4Z23J2  
HF18FZ/□□□-4Z23J3

4Z直流带发光二极管和续流二极管  
(不包括220VDC)

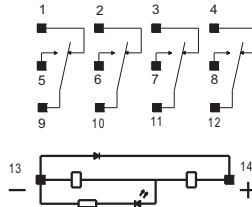

HF18FZ/A□□□-4Z232  
HF18FZ/A□□□-4Z233

4Z交流带发光二极管

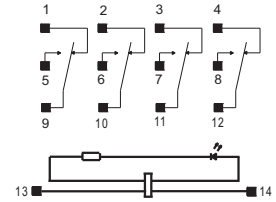

HF18FZ/220-4Z232  
HF18FZ/220-4Z233

4Z直流带发光二极管  
(220VDC)

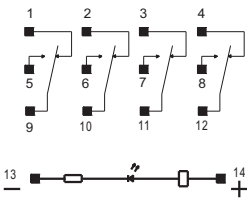

HF18FZ/220-4Z23J2  
HF18FZ/220-4Z23J3

4Z直流带发光二极管和续流二极管  
(220VDC)

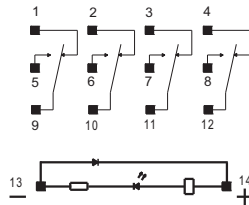

## 性能曲线图

最大切换功率  
(2Z)

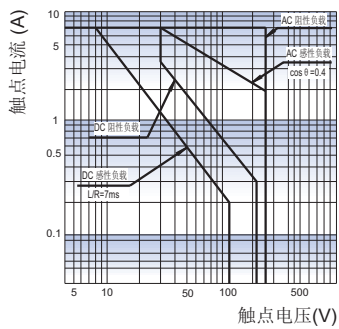

最大切换功率  
(4Z)

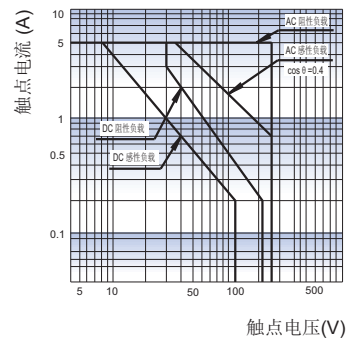

## 性能曲线图

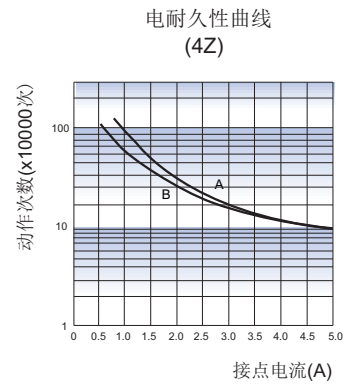
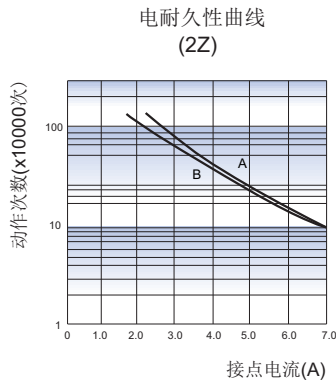

备注:

1. 曲线A指阻性负载24Vd.c.  
曲线B指阻性负载220Vac.
2. 开闭条件: NO或NC.

## 继电器配套插座



### 特性

- 介质耐压可达2000VAC, 绝缘电阻1000MΩ
- PCB式、螺钉式、导轨式安装形式可供选择
- 带手指保护功能插座可供选择
- 多款插入式模块可供选择, 实现通电指示、线路保护等功能
- 可选用配件: 卡簧、标识板、插入式模块
- 环保产品 (符合RoHS)







## 性能参数

插座型号	额定电压	额定电流	环境温度	介质耐压min.	螺钉扭矩	剥露导线长度	重量
18FZ-2Z-C2	250VAC	7A	-40 °C ~ 70 °C	2000VAC	0.6N·m	7mm	约30g
18FZ-4Z-C2	250VAC	5A	-40 °C ~ 70 °C	2000VAC	0.6N·m	7mm	约44g
18FF-2Z-A2	250VAC	7A	-40 °C ~ 70 °C	2000VAC	—	—	约8g
18FF-2Z-C1	250VAC	7A	-40 °C ~ 70 °C	2000VAC	0.8N·m	7mm	约35g
18FF-2Z-C2	250VAC	7A	-40 °C ~ 70 °C	2000VAC	0.8N·m	7mm	约36g
18FF-2Z-C4	250VAC	7A	-40 °C ~ 70 °C	2000VAC	0.6N·m	7mm	约53g
18FF-2Z-C5	250VAC	7A	-40 °C ~ 70 °C	2000VAC	0.6N·m	7mm	约64g
18FF-2Z-C8	250VAC	7A	-40 °C ~ 70 °C	2000VAC	0.6N·m	7mm	约41g
18FF-2Z-C9	250VAC	7A	-40 °C ~ 70 °C	2000VAC	—	7mm	约70g
18FF-4Z-A2	250VAC	7A*	-40 °C ~ 70 °C	2000VAC	—	—	约8g
18FF-4Z-C1	250VAC	7A*	-40 °C ~ 70 °C	2000VAC	0.8N·m	7mm	约58g
18FF-4Z-C2	250VAC	7A*	-40 °C ~ 70 °C	2000VAC	0.8N·m	7mm	约59g
18FF-4Z-C4	250VAC	7A*	-40 °C ~ 70 °C	2000VAC	0.6N·m	7mm	约64g
18FF-4Z-C5	250VAC	7A*	-40 °C ~ 70 °C	2000VAC	0.6N·m	7mm	约76g
18FF-4Z-C8	250VAC	7A*	-40 °C ~ 70 °C	2000VAC	0.6N·m	7mm	约51g
18FF-4Z-C9	250VAC	7A*	-40 °C ~ 70 °C	2000VAC	—	7mm	约81g

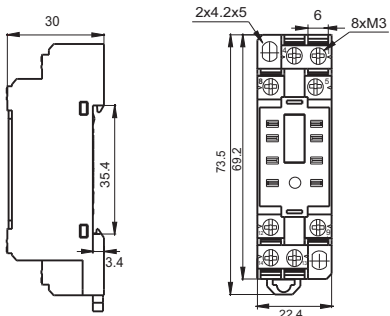
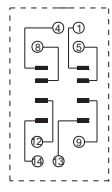
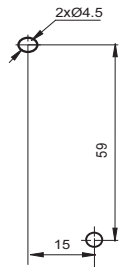
备注: “\*”的插座型号, 各组电流总和不得超过20A。

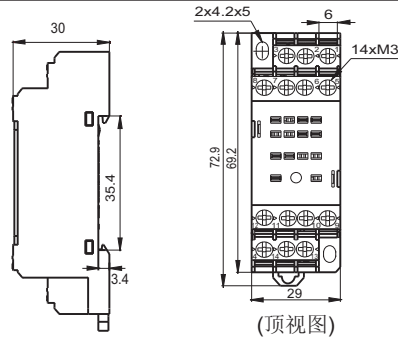
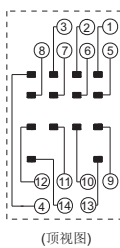
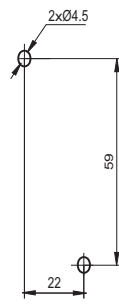
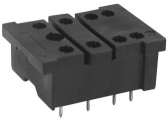
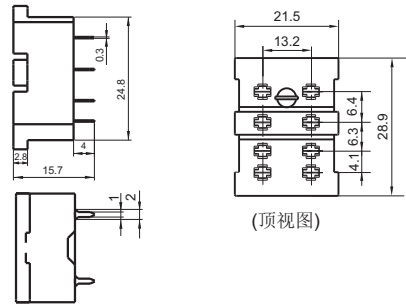
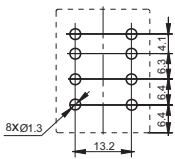

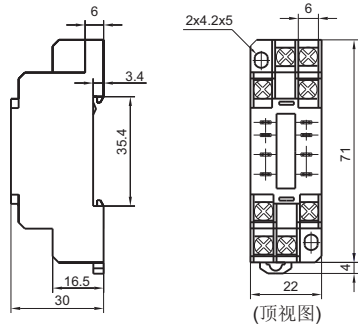
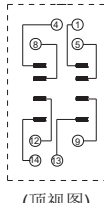
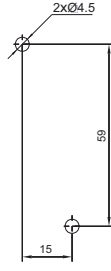

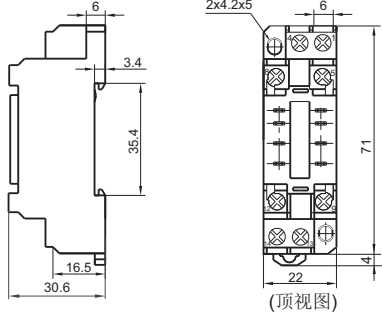
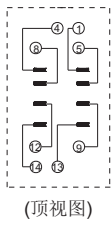
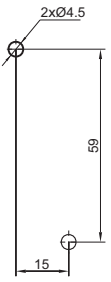

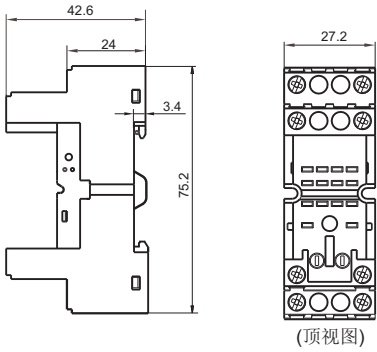
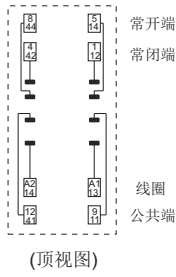
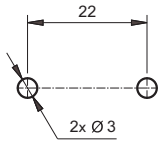

外形图、接线图、安装孔尺寸

单位: mm

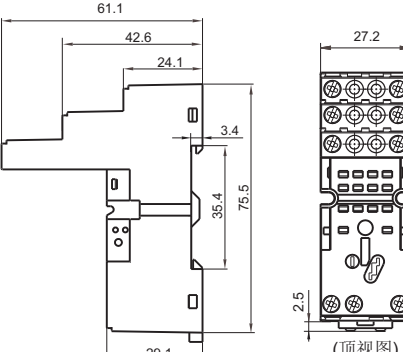
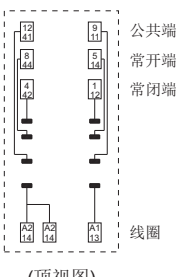
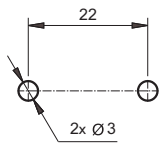
插座	外形尺寸	接线图	安装孔尺寸	可选配件
<p>18FZ-2Z-C2 (新一代)</p>  <p>螺钉式引出端、 导轨式或螺钉式安装、 带手指保护结构</p>		 <p>(顶视图)</p>		金属卡簧 18FZ-H1 18FF-H2
<p>18FZ-4Z-C2 (新一代)</p>  <p>螺钉式引出端、 导轨式或螺钉式安装、 带手指保护结构</p>		 <p>(顶视图)</p>		金属卡簧 18FZ-H1 18FF-H2
<p>18FF-2Z-A2</p>  <p>印制板式引出端、 印制板式安装 适用于两组的继电器产品</p>				金属卡簧 18FF-H1
<p>18FF-2Z-C1</p>  <p>螺钉式引出端、 导轨式或螺钉式安装 不带手指保护结构 适用于两组的继电器产品</p>		 <p>(顶视图)</p>		金属卡簧 18FZ-H1 金属卡簧 18FF-H2 (成对配合使用)
<p>18FF-2Z-C2</p>  <p>螺钉式引出端、 导轨式或螺钉式安装、 带手指保护结构 适用于两组的继电器产品</p>		 <p>(顶视图)</p>		金属卡簧 18FZ-H1 金属卡簧 18FF-H2 (成对配合使用)

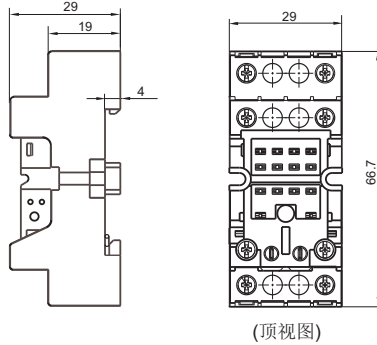
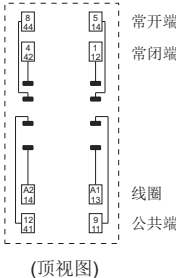
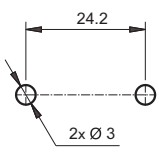
外形图、接线图、安装孔尺寸

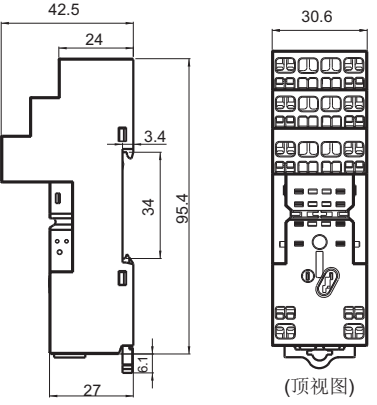
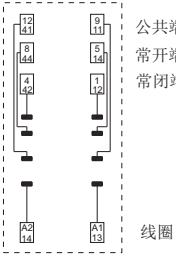





单位: mm

插座	外形尺寸	接线图	安装孔尺寸	可选配件
<p>18FF-2Z-C4</p>  <p>螺钉式引出端、 导轨式或螺钉式安装、 带手指保护结构 适用于两组的继电器产品</p>	 <p>(顶视图)</p>	 <p>(顶视图)</p>		<p>塑料卡簧 18FF-H4 金属卡簧 18FF-H5</p> <p>标识板 18FF-M1</p> <p>插入式模块 HFAA ~ HFHU*</p>
<p>18FF-2Z-C5</p>  <p>螺钉式引出端、 导轨式或螺钉式安装、 带手指保护结构 适用于两组的继电器产品</p>	 <p>(顶视图)</p>	 <p>(顶视图)</p>		<p>塑料卡簧 18FF-H4 金属卡簧 18FF-H5</p> <p>标识板 18FF-M1</p> <p>插入式模块 HFAA ~ HFHU*</p>
<p>18FF-2Z-C8</p>  <p>螺钉式引出端、 导轨式或螺钉式安装、 带手指保护结构 适用于两组的继电器产品</p>	 <p>(顶视图)</p>	 <p>(顶视图)</p>		<p>塑料卡簧 18FF-H4 金属卡簧 18FF-H5</p> <p>标识板 18FF-M3</p> <p>插入式模块 HFAA ~ HFHU*</p>
<p>18FF-2Z-C9</p>  <p>弹簧式引出端、 导轨式安装、 带手指保护结构 适用于两组的继电器产品</p>	 <p>(顶视图)</p>	 <p>(顶视图)</p>		<p>塑料卡簧 18FF-H4</p> <p>金属卡簧 18FF-H5</p> <p>插入式模块 HFAA ~ HFHU*</p> <p>标识板 18FF-M3</p>

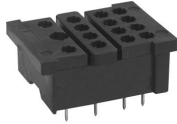
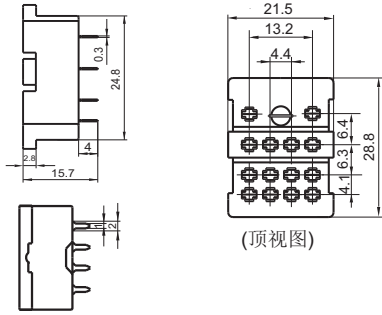
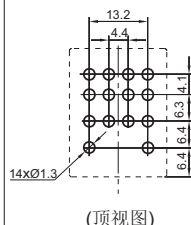

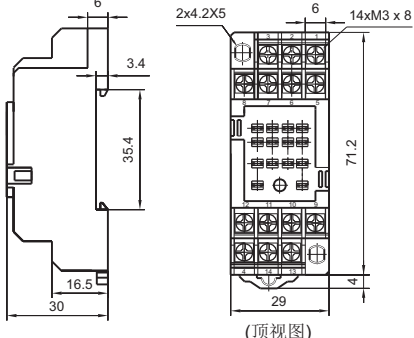
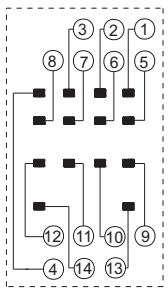
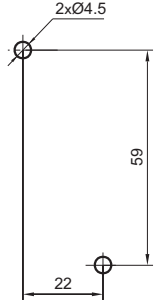

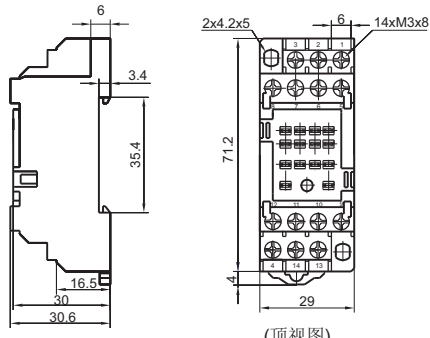
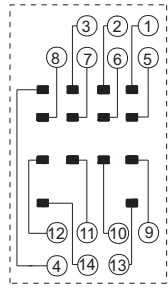
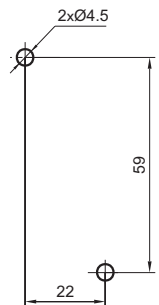

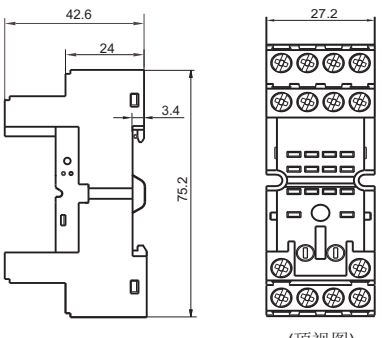
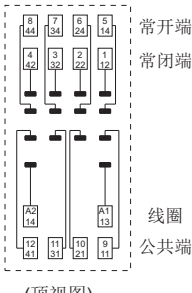
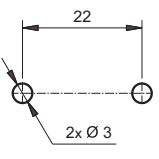
外形图、接线图、安装孔尺寸

单位: mm

插座	外形尺寸	接线图	安装孔尺寸	可选配件
<p>18FF-4Z-A2</p>  <p>印制板式引出端、 印制板式安装 适用于四组的继电器产品</p>	 <p>(顶视图)</p>		 <p>(顶视图)</p>	<p>金属卡簧 18FF-H1</p>
<p>18FF-4Z-C1</p>  <p>螺钉式引出端、 导轨式或螺钉式安装 不带手指保护结构 适用于四组的继电器产品</p>	 <p>(顶视图)</p>	 <p>(顶视图)</p>		<p>金属卡簧 18FZ-H1 金属卡簧 18FF-H2 (成对配合使用)</p>
<p>18FF-4Z-C2</p>  <p>螺钉式引出端、 导轨式或螺钉式安装、 带手指保护结构 适用于四组的继电器产品</p>	 <p>(顶视图)</p>	 <p>(顶视图)</p>		<p>金属卡簧 18FZ-H1 金属卡簧 18FF-H2 (成对配合使用)</p>
<p>18FF-4Z-C4</p>  <p>螺钉式引出端、 导轨式或螺钉式安装、 带手指保护结构 适用于四组的继电器产品</p>	 <p>(顶视图)</p>	 <p>(顶视图)</p>		<p>塑料卡簧 18FF-H4 金属卡簧 18FF-H5</p> <p>标识板 18FF-M1</p> <p>插入式模块 HFAA ~ HFHU*</p>

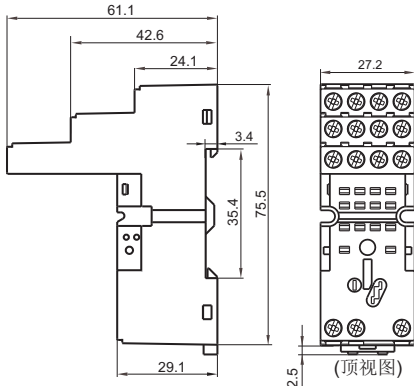
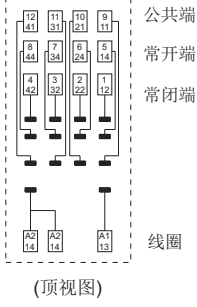
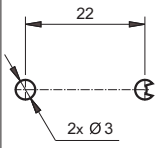
## 外形图、接线图、安装孔尺寸

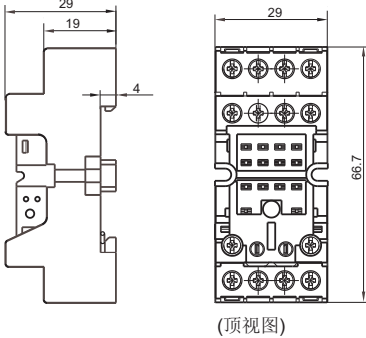
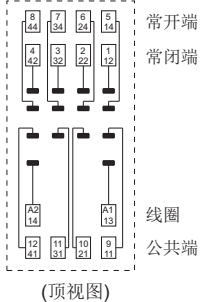
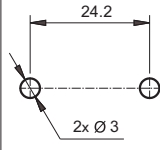
单位: mm

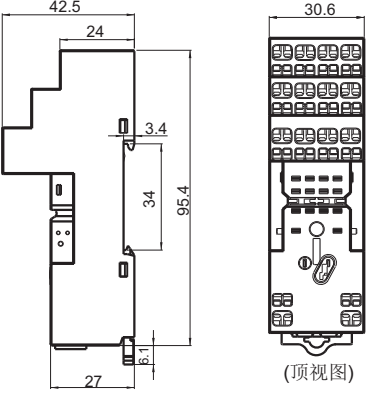
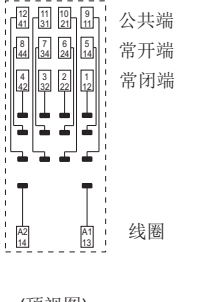
插座	外形尺寸	接线图	安装孔尺寸	可选配件
<p><b>18FF-4Z-C5</b></p>  <p>螺钉式引出端、 导轨式或螺钉式安装、 带手指保护结构 适用于四组的继电器产品</p>	 <p>(顶视图)</p>	 <p>(顶视图)</p>		塑料卡簧 18FF-H4 金属卡簧 18FF-H5 标识板 18FF-M1 插入式模块 HFAA ~ HFHU*
<p><b>18FF-4Z-C8</b></p>  <p>螺钉式引出端、 导轨式或螺钉式安装、 带手指保护结构 适用于四组的继电器产品</p>	 <p>(顶视图)</p>	 <p>(顶视图)</p>		塑料卡簧 18FF-H4 金属卡簧 18FF-H5 标识板 18FF-M3 插入式模块 HFAA ~ HFHU*
<p><b>18FF-4Z-C9</b></p>  <p>弹簧式引出端、 导轨式安装、 带手指保护结构 适用于四组的继电器产品</p>	 <p>(顶视图)</p>	 <p>(顶视图)</p>		塑料卡簧 18FF-H4 金属卡簧 18FF-H5 插入式模块 HFAA ~ HFHU* 标识板 18FF-M3

备注: \* 如需选用插入式模块, 请参考对应的产品说明书。

## 相关配件尺寸(可选)

单位: mm

### 卡簧

18FZ-H1(金属卡簧)

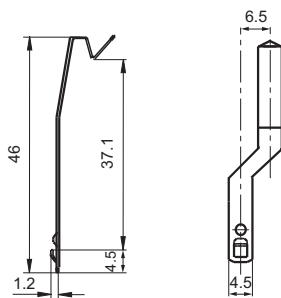

18FF-H1(金属卡簧)

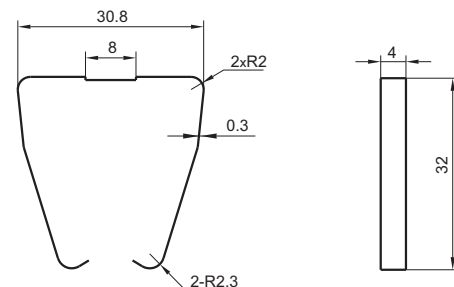

备注: 18FZ-H1卡簧须配合使用, 订购时请特别留意。

卡簧

18FF-H2(金属卡簧)

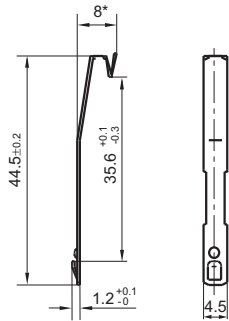

18FF-H4 (塑料卡簧)

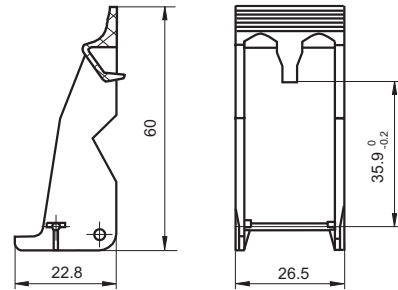

备注: 18FF-H2卡簧须成对配合使用, 订购时请特别留意。

18FF-H5 (金属卡簧)

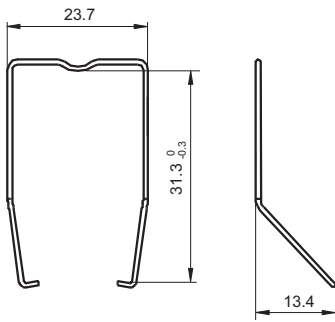

标识板

18FF-M1

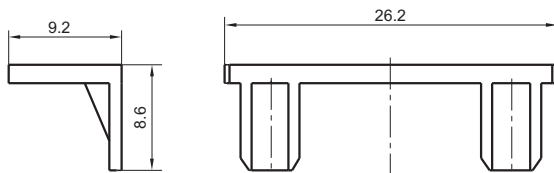

18FF-M3

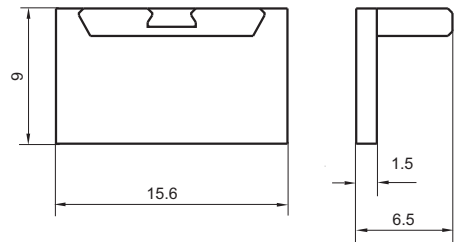

配件选用表

继电器型号	面板结构	插座型号	卡簧型号	标识板	模块
HF18FZ/□□-2Z□□□1/2□	无按钮型	18FF-2Z-A2	18FF-H1	-	-
		18FF-2Z-C1	18FF-H2		
		18FF-2Z-C2			
		18FZ-2Z-C2			
		18FF-2Z-C4	18FF-H4/H5	18FF-M1	HFAA~HFHU
		18FF-2Z-C5		18FF-M3	
		18FF-2Z-C8			
		18FF-2Z-C9			
HF18FZ/□□-4Z□□□1/2□		18FF-4Z-A2	18FF-H1	-	-
		18FF-4Z-C1	18FF-H2		
		18FF-4Z-C2			
		18FZ-4Z-C2			
		18FF-4Z-C4	18FF-H4/H5	18FF-M1	HFAA~HFHU
		18FF-4Z-C5		18FF-M3	
		18FF-4Z-C8			
		18FF-4Z-C9			
HF18FZ/□□-2Z□□□3□	带按钮型	18FF-2Z-C1	18FZ-H1	-	-
		18FF-2Z-C2			
		18FZ-2Z-C2			
		18FF-2Z-C4	18FF-H4	18FF-M1	HFAA~HFHU
		18FF-2Z-C5		18FF-M3	
		18FF-2Z-C8			
		18FF-2Z-C9			
		HF18FZ/□□-4Z□□□3□	18FF-4Z-C1	18FZ-H1	-
18FF-4Z-C2					
18FZ-4Z-C2					
18FF-4Z-C4			18FF-H4	18FF-M1	HFAA~HFHU
18FF-4Z-C5				18FF-M3	
18FF-4Z-C8					
18FF-4Z-C9					

选配插座时的注意事项:

1. 请根据实际安装环境、继电器触点组数和继电器引出脚脚位选择合适的继电器插座, 选型过程中如有疑问, 请与宏发联系以便获取更多的技术支持;
2. 可安装标识卡的插座标配1个标识板, 其他相关配件均须另外选配, 请您在订货时, 务必分别注明挑选的继电器插座及相关配件的型号;
3. 以上仅列举了适用于HF18FZ继电器产品的典型插座和相关配件型号, 如有特殊要求, 请与我们联系;
4. 主要外形尺寸, 当外形尺寸>50mm时, 公差为±1mm; 当20mm<外形尺寸≤50mm之间时, 公差为±0.5mm; 当5mm<外形尺寸≤20mm之间时, 公差为±0.4mm, 当外形尺寸≤5mm时, 公差为±0.3mm;
5. 导轨安装时, 建议使用DIN标准35x7.5x1mm、35x15x1mm的标准导轨。

声明:

本产品规格书仅供客户使用时参考, 其中未明确规定的要求条件, 详见“继电器术语解释及使用指南”。若有更改, 恕不另行通知。  
对宏发而言, 不可能评定继电器在每个具体应用领域的所有性能参数要求, 因而客户应根据具体的使用条件选择与之相匹配的产品, 如有疑问, 请与宏发联系以便获取更多的技术支持。但产品选型责任仅由客户负责。

© 厦门宏发电声股份有限公司版权所有, 本公司保留所有权利。